

12 +12W STEREO AMPLIFIER WITH MUTING

- WIDE SUPPLY VOLTAGE RANGE
- HIGH OUTPUT POWER
12+12W @ $V_S=28V$, $R_L = 8\Omega$, THD=10%
- MUTE FACILITY (POP FREE) WITH LOW CONSUMPTION
- AC SHORT CIRCUIT PROTECTION
- THERMAL OVERLOAD PROTECTION

DESCRIPTION

The TDA7263 is class AB dual audio power amplifier assembled in the new Clipwatt package, specially designed for high quality sound application as HI-FI music centers and stereo TV sets.

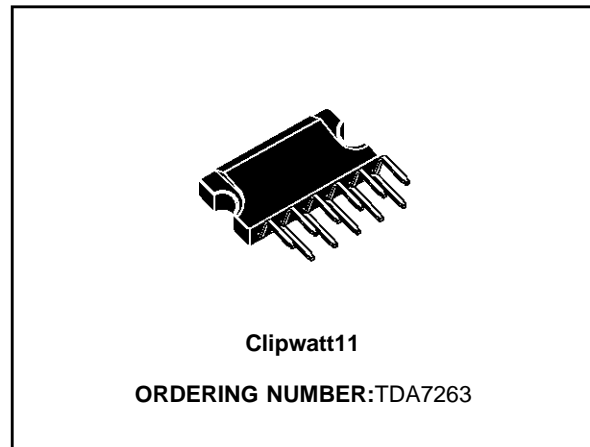

TEST AND APPLICATION CIRCUIT

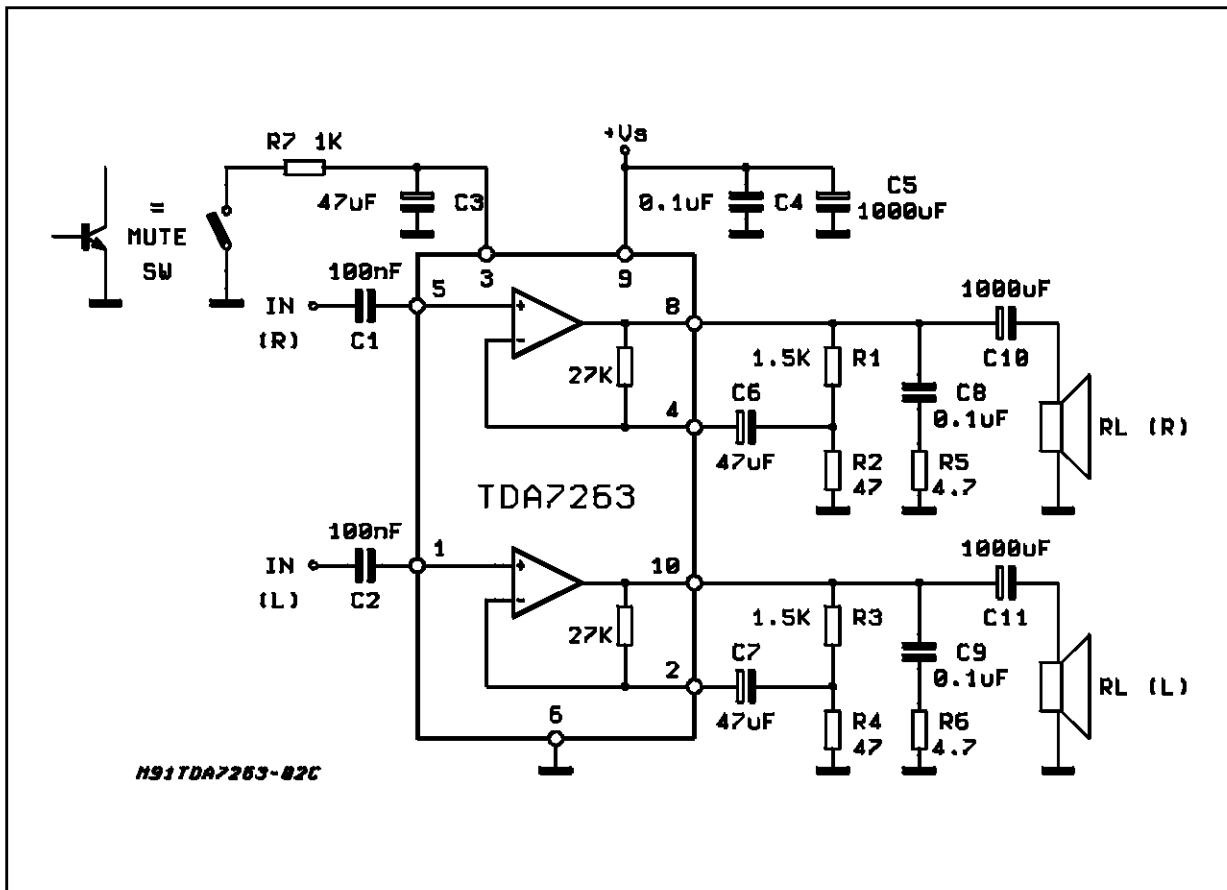

TDA7263

ABSOLUTE MAXIMUM RATINGS

Symbol	Parameter	Value	Unit
V_S	Supply Voltage	35	V
I_O	Output Peak Current (repetitive $f > 20\text{Hz}$)	2.5	A
I_O	Output Peak Current (non repetitive, $t = 100\mu\text{s}$)	3.5	A
P_{tot}	Total Power Dissipation ($T_{case} = 70^\circ\text{C}$)	25	W
T_{op}	Operating Temperature Range	0 to 70	$^\circ\text{C}$
$T_{stg,Tj}$	Storage & Junction Temperature	-40 to 150	$^\circ\text{C}$

PIN CONNECTION (Top view)

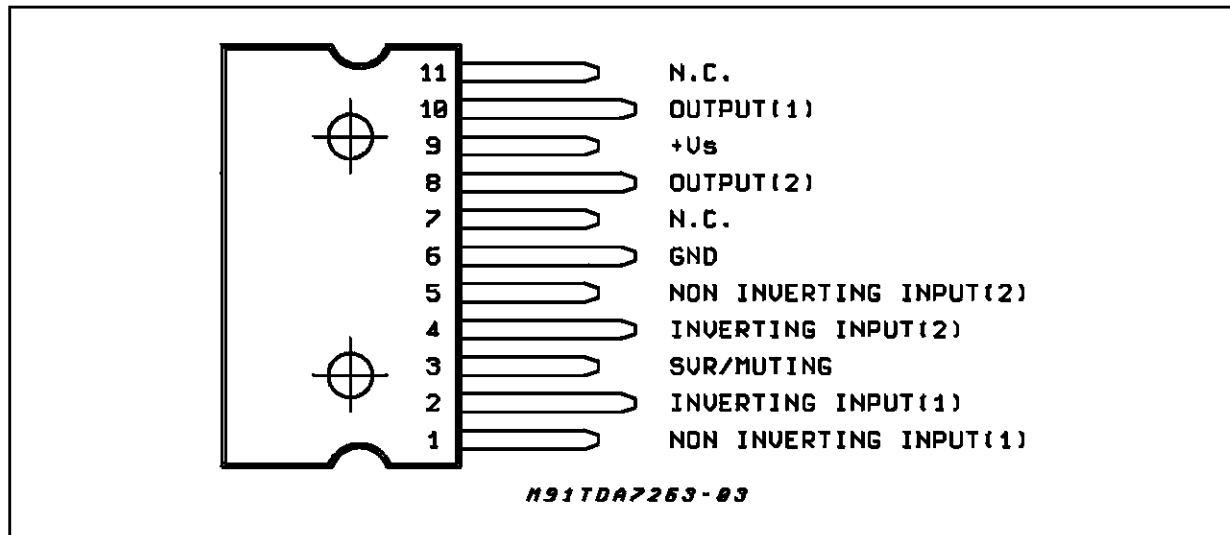

BLOCK DIAGRAM

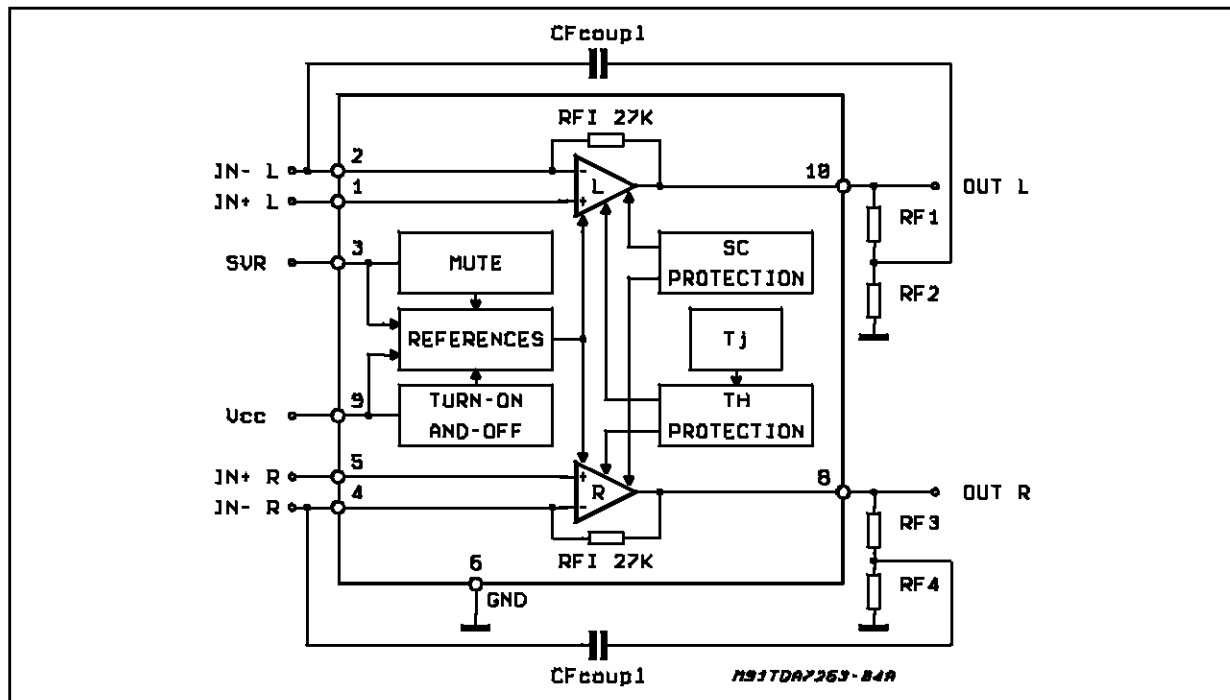

THERMAL DATA

Symbol	Parameter	Value	Unit
$R_{th\ j-case}$	Thermal resistance junction to case	Max 3	$^{\circ}C/W$

ELECTRICAL CHARACTERISTICS (Refer to the stereo test and application circuit, $V_S = 28V$; $R_L = 8\Omega$; $G_v = 30dB$; $f = 1KHz$; $T_{amb} = 25^{\circ}C$ unless otherwise specified.)

Symbol	Parameter	Test Condition	Min.	Typ.	Max.	Unit
V_S	Supply Voltage		10		32	V
V_O	Quiescent Output Voltage			13.5		V
I_q	Total Quiescent Current			70	95	mA
P_O	Output Power (RMS)	$d = 10\%$ $T_{amb} = 85^{\circ}C$ $d = 1\%$	10	12 9.5		W W
d	Total Harmonic Distortion	$P_O = 1W$, $f = 1kHz$ $f = 100Hz$ to $10KHz$; $P_O = 0.1$ to $8W$		0.02	0.2 0.5	%
CT	Cross Talk	$R_S = 10K\Omega$; $f = 1KHz$		70		dB
		$R_S = 10K\Omega$; $f = 10KHz$		60		dB
R_I	Input Resistance		100	200		$K\Omega$
f_L	Low Frequency Roll-off (-3dB)			40		Hz
f_H	High Frequency Roll-off (-3dB)			80		KHz
eN	Total Input Noise Voltage	A Curve; $R_S = 10K\Omega$		1.5		mV
		$f = 22Hz$ to $22KHz$; $R_S = 10K\Omega$		3	10	μV
SVR	Supply Voltage Rejection (each channel)	$R_S = 10K\Omega$; $f = 100Hz$; $V_r = 0.5V$	45	60		dB
T_j	Thermal Shutdown Junction Temperature			145		$^{\circ}C$
MUTE FUNCTION						
V_{TMUTE}	Mute Threshold		1	1.6		V
V_{TPLAY}	Play Threshold			4.5		V
ATT _{AM}	Mute Attenuation		70	100		dB
I_{qMUTE}	Quiescent Current @ Mute			7	10	mA

TYPICAL CHARACTERISTICS (referred to the typical Application Circuit, $V_S = 28V$, $R_L = 8\Omega$, unless otherwise specified)

Figure 1: Output Power vs. Supply Voltage

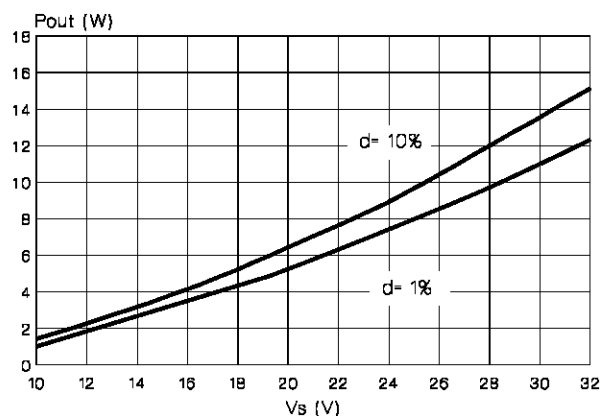

Figure 2: Distortion vs. Output Power

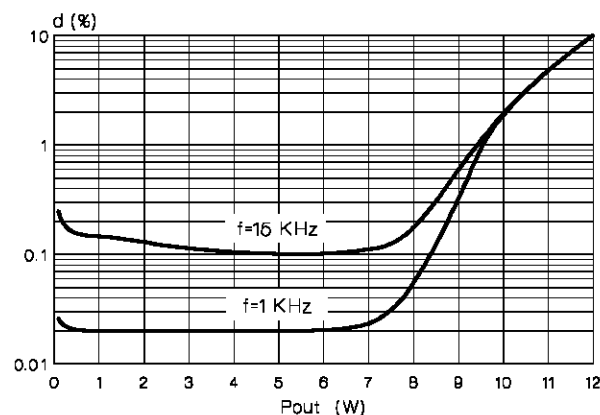

Figure 3: Quiescent Current vs. Supply Voltage

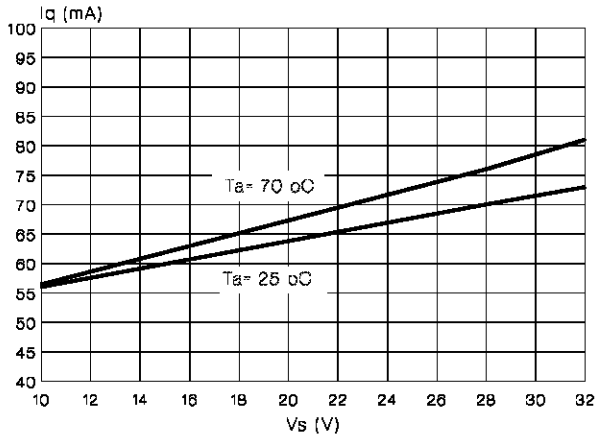

Figure 4: Supply Voltage Rejection vs. Frequency

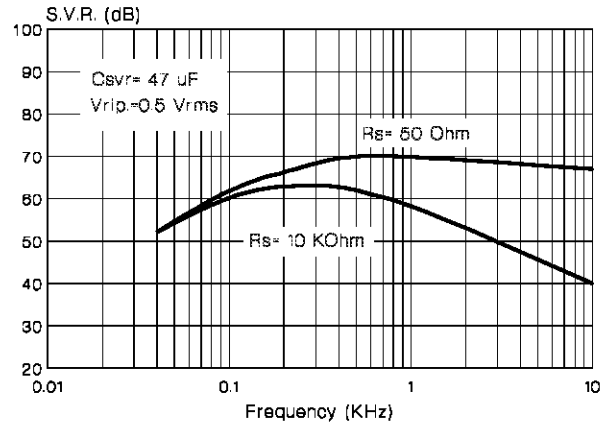

Figure 5: Crosstalk vs. Frequency

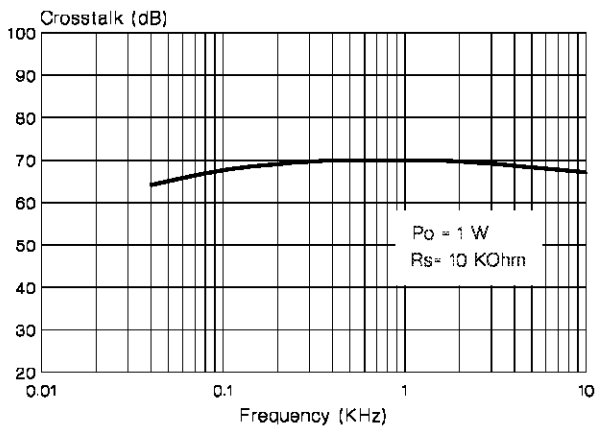

Figure 6: Output Attenuation & Quiescent Current vs. V_{pin3}

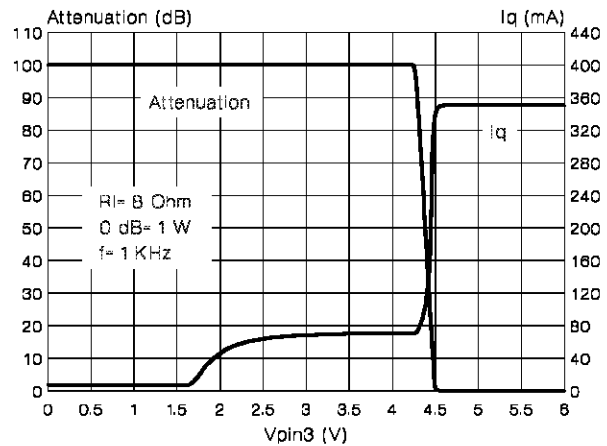

Figure 7: Total Power Dissipation vs. Output Power

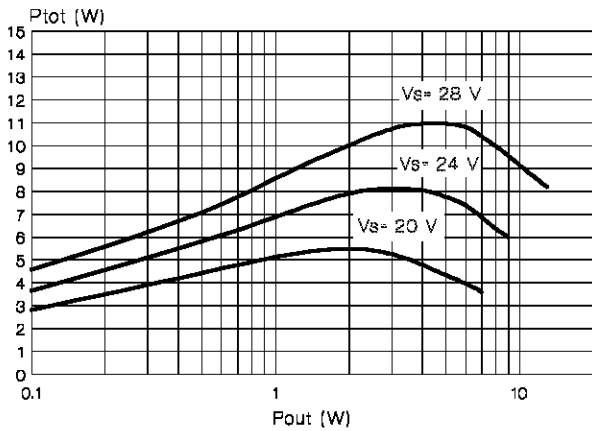
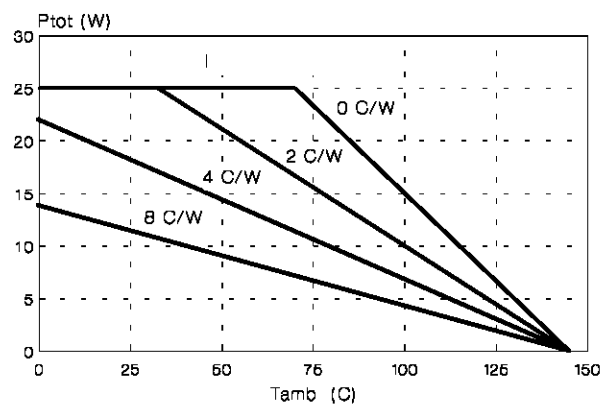

Figure 8: Maximum allowable Power dissipation vs. Ambient Temperature



APPLICATION SUGGESTION

The recommended values of the components are those shown on the typical application circuit. Different values can be used; the following table can help the designer.

Component	Recomm. Value	Purpose	Larger Than	Smaller Than
R1 and R3	1.5K Ω	Close loop gain setting (*)	Increase of gain	Decrease of gain
R2 and R4	47 Ω	Close loop gain setting (*)	Decrease of gain	Increase of gain
R5 and R6	4.7 Ω	Frequency stability	Danger of oscillations	
C1 and C2	100nF	Input DC decoupling	Higher SVR	Higher low frequency cutoff
C3	47 μ F	- Ripple Rejection - Mute time constant	Increase of the Switch-on time	- Degradation of SVR - Worse turn-off pop by muting
C4	100nF	Supply Voltage Bypass		Danger of oscillations
C5	1000 μ F	Supply Voltage Bypass		
C6 and C7	47 μ F	Feedback input DC decoupling	Increase of the Switch-on time	Danger of Switch-on time
C8 and C9	0.1 μ F	Frequency stability		Danger of oscillations
C10 and C11	1000 μ F	Output DC decoupling		Higher low-frequency cut-off

(*) Closed loop gain must be higher than 26dB

Figure 9: P.C. Board and Component Layout (1:1 scale)

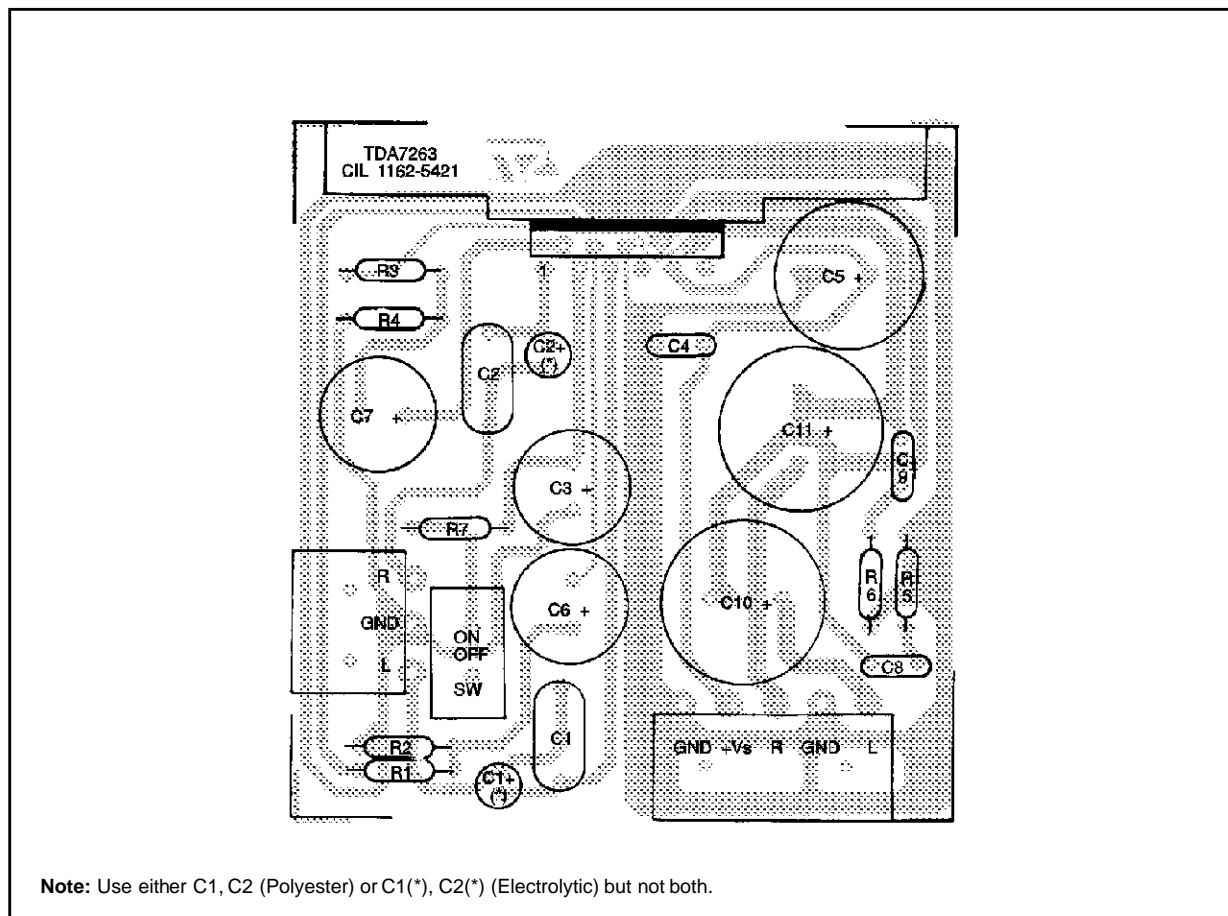

BUILT-IN PROTECTION SYSTEMS

THERMAL SHUT-DOWN

The presence of a thermal limiting circuit offers the following advantages:

- 1-an overload on the output (even if it is permanent), or an excessive ambient temperature can be easily withstood.
- 2-the heatsink can have a smaller factor of safety compared with that of a conventional circuit. There is no device damage in the case of excessive junction temperature; if for any reason the junction temperature increases up to 145°C. the thermal shutdown simply re-

duces the output power and therefore the power dissipation.

The maximum allowable power dissipation depends upon the thermal resistance junction-ambient. Figure 8 shows the dissipable power as a function of ambient temperature for different heatsink thermal resistance.

SHORT CIRCUIT (AC CONDITIONS)

The TDA7263 can withstand accidental short circuits across the speaker made by a wrong connection during normal play operation.

CLIPWATT11 PACKAGE MECHANICAL DATA

DIM.	mm			inch		
	MIN.	TYP.	MAX.	MIN.	TYP.	MAX.
A			3.10			0.122
B			1.10			0.04
C		0.15			0.006	
D		1.50			0.059	
E		0.52			0.02	
F		0.80			0.03	
G		1.70			0.066	
G1		17.00			0.66	
H1		12.00			0.48	
H3		20.00			0.79	
L		17.90			0.70	
L1		14.40			0.57	
L2		11.00			0.43	
M		2.54			0.1	
M1		2.54			0.1	

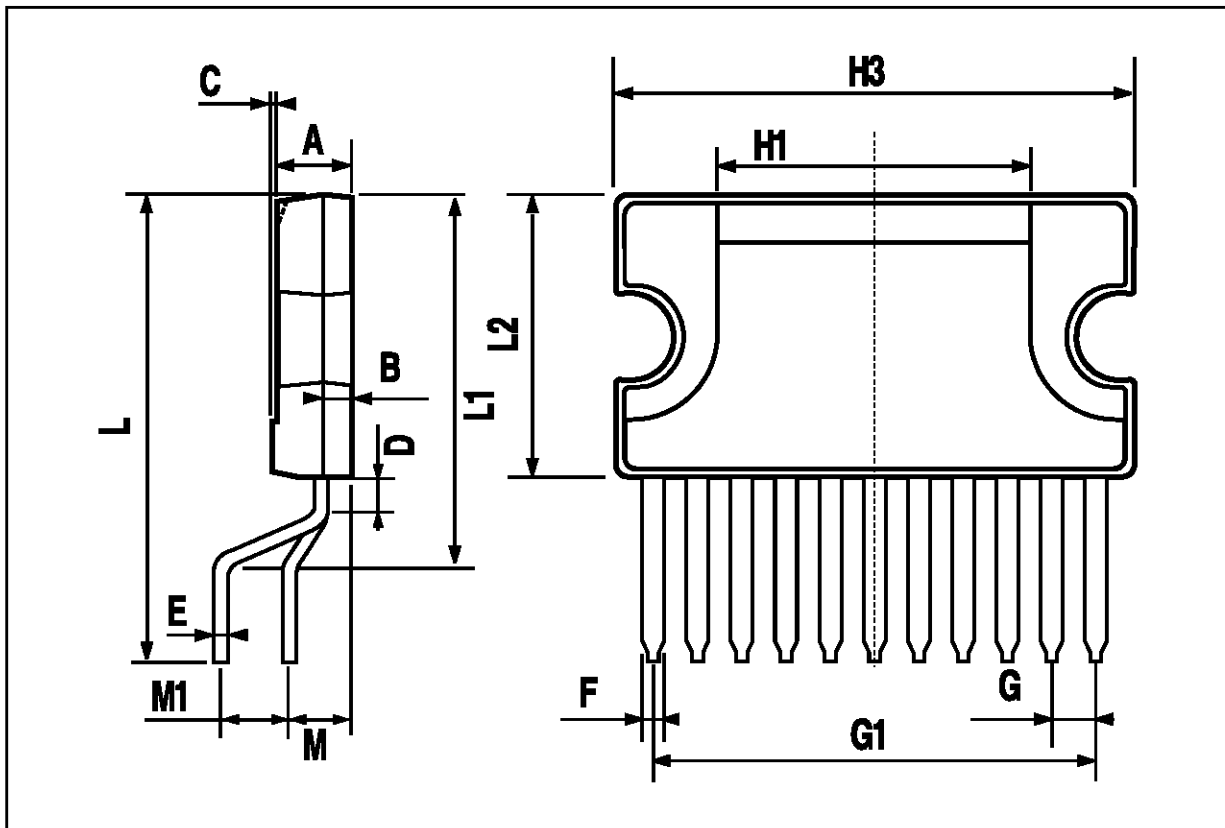

Information furnished is believed to be accurate and reliable. However, SGS-THOMSON Microelectronics assumes no responsibility for the consequences of use of such information nor for any infringement of patents or other rights of third parties which may result from its use. No license is granted by implication or otherwise under any patent or patent rights of SGS-THOMSON Microelectronics. Specifications mentioned in this publication are subject to change without notice. This publication supersedes and replaces all information previously supplied. SGS-THOMSON Microelectronics products are not authorized for use as critical components in life support devices or systems without express written approval of SGS-THOMSON Microelectronics.

© 1995 SGS-THOMSON Microelectronics - All Rights Reserved

SGS-THOMSON Microelectronics GROUP OF COMPANIES

Australia - Brazil - France - Germany - Hong Kong - Italy - Japan - Korea - Malaysia - Malta - Morocco - The Netherlands - Singapore - Spain - Sweden - Switzerland - Taiwan - Thailand - United Kingdom - U.S.A.