

TRIACS

Silicon Bidirectional Thyristors

Designed for high performance full-wave ac control applications where high noise immunity and high commutating di/dt are required.

- Blocking Voltage to 800 Volts
- On-State Current Rating of 15 Amperes RMS at 80°C
- Uniform Gate Trigger Currents in Three Modes
- High Immunity to dv/dt — 250 V/μs minimum at 125°C
- Minimizes Snubber Networks for Protection
- Industry Standard TO-220AB Package
- High Commutating di/dt — 9.0 A/ms minimum at 125°C

**MAC15
SERIES***
*Motorola preferred devices

**TRIACS
15 AMPERES RMS
400 thru 800
VOLTS**

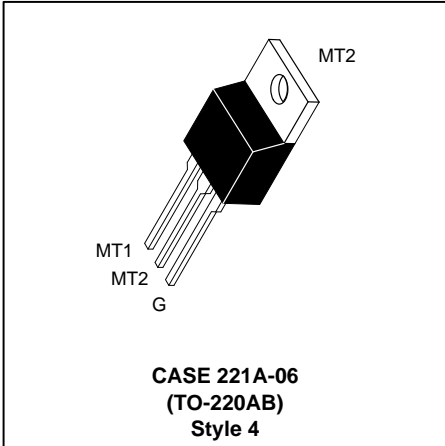

MAXIMUM RATINGS (T_J = 25°C unless otherwise noted)

Symbol	Parameter	Value	Unit
V _{DRM}	Peak Repetitive Off-State Voltage (1) (-40 to 125°C, Sine Wave, 50 to 60 Hz, Gate Open)	MAC15D 400 MAC15M 600 MAC15N 800	Volts
I _{T(RMS)}	On-State RMS Current (60 Hz, T _C = 80°C)	15	A
I _{TSM}	Peak Non-repetitive Surge Current (One Full Cycle, 60 Hz, T _J = 125°C)	150	A
i ² t	Circuit Fusing Consideration (t = 8.3 ms)	93	A ² sec
P _{GM}	Peak Gate Power (Pulse Width ≤ 1.0 μs, T _C = 80°C)	20	Watts
P _{G(AV)}	Average Gate Power (t = 8.3 ms, T _C = 80°C)	0.5	Watts
T _J	Operating Junction Temperature Range	-40 to +125	°C
T _{stg}	Storage Temperature Range	-40 to +150	°C

THERMAL CHARACTERISTICS

R _{θJC} R _{θJA}	Thermal Resistance — Junction to Case — Junction to Ambient	2.0 62.5	°C/W
T _L	Maximum Lead Temperature for Soldering Purposes 1/8" from Case for 10 Seconds	260	°C

(1) V_{DRM} for all types can be applied on a continuous basis. Blocking voltages shall not be tested with a constant current source such that the voltage ratings of the devices are exceeded.

Preferred devices are Motorola recommended choices for future use and best overall value.

REV 1

MAC15 SERIES

ELECTRICAL CHARACTERISTICS (T_J = 25°C unless otherwise noted)

Symbol	Characteristic	Min	Typ	Max	Unit	
OFF CHARACTERISTICS						
I _{DRM}	Peak Repetitive Blocking Current (V _D = Rated V _{DRM} , Gate Open)	T _J = 25°C	—	—	0.01	mA
		T _J = 125°C	—	—	2.0	

ON CHARACTERISTICS

V _{TM}	Peak On-State Voltage* (I _{TM} = ±21 A Peak)	—	1.2	1.6	Volts
I _{GT}	Continuous Gate Trigger Current (V _D = 12 V, R _L = 100 Ω) MT2(+), G(+) MT2(+), G(-) MT2(-), G(-)	5.0	13	35	mA
		5.0	16	35	
		5.0	18	35	
I _H	Hold Current (V _D = 12 V, Gate Open, Initiating Current = ±150 mA)	—	20	40	mA
I _L	Latch Current (V _D = 24 V, I _G = 35 mA) MT2(+), G(+) MT2(+), G(-) MT2(-), G(-)	—	33	50	mA
		—	36	80	
		—	33	50	
V _{GT}	Gate Trigger Voltage (V _D = 12 V, R _L = 100 Ω) MT2(+), G(+) MT2(+), G(-) MT2(-), G(-)	0.5	0.75	1.5	Volts
		0.5	0.72	1.5	
		0.5	0.82	1.5	

DYNAMIC CHARACTERISTICS

(di/dt) _C	Rate of Change of Commutating Current* See Figure 10. (V _D = 400 V, I _{TM} = 6.0 A, Commutating dv/dt = 24 V/μs, Gate Open, T _J = 125°C, f = 250 Hz, No Snubber)	9.0	—	—	A/ms
dv/dt	Critical Rate of Rise of Off-State Voltage (V _D = Rated V _{DRM} , Exponential Waveform, Gate Open, T _J = 125°C)	250	—	—	V/μs

*Indicates Pulse Test: Pulse Width ≤ 2.0 ms, Duty Cycle ≤ 2%.

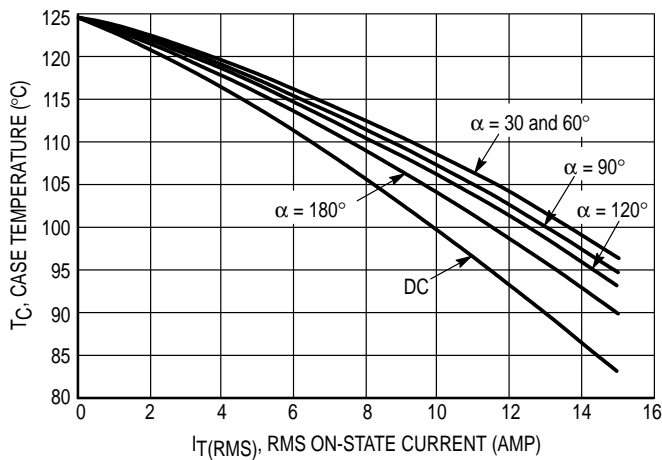

Figure 1. RMS Current Derating

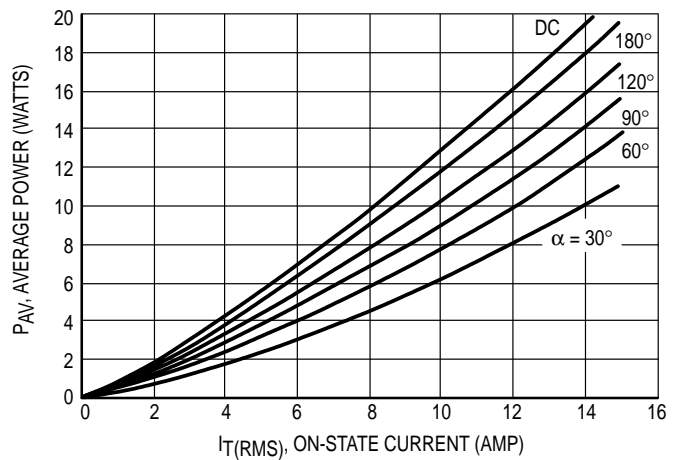

Figure 2. On-State Power Dissipation

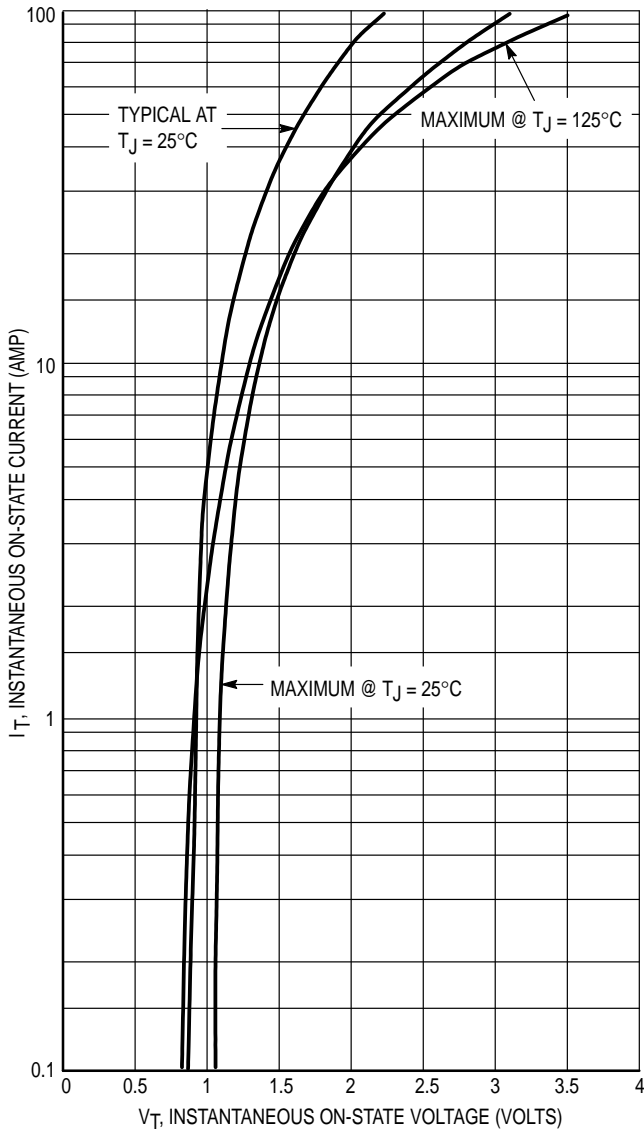

Figure 3. On-State Characteristics

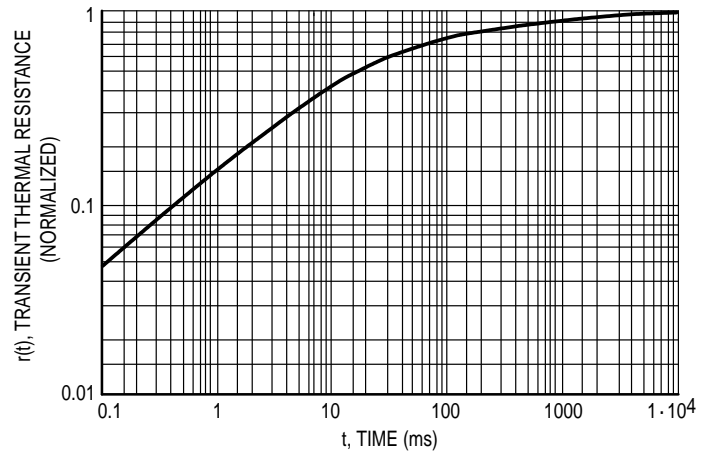

Figure 4. Thermal Response

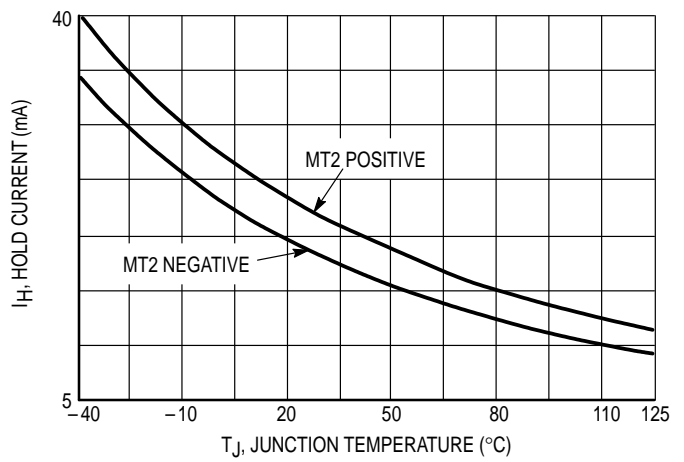

Figure 5. Hold Current Variation

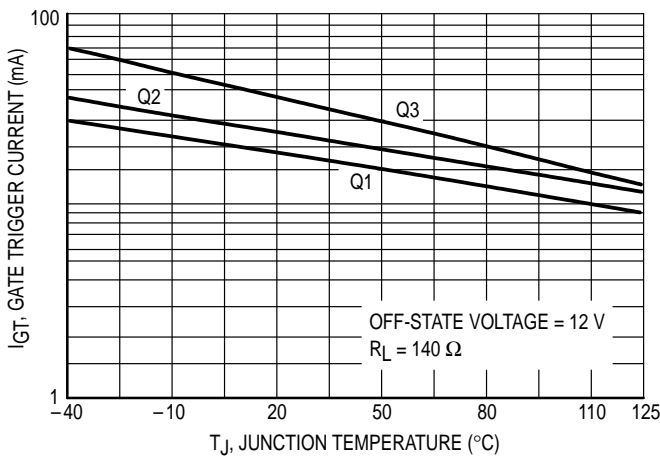

Figure 6. Gate Trigger Current Variation

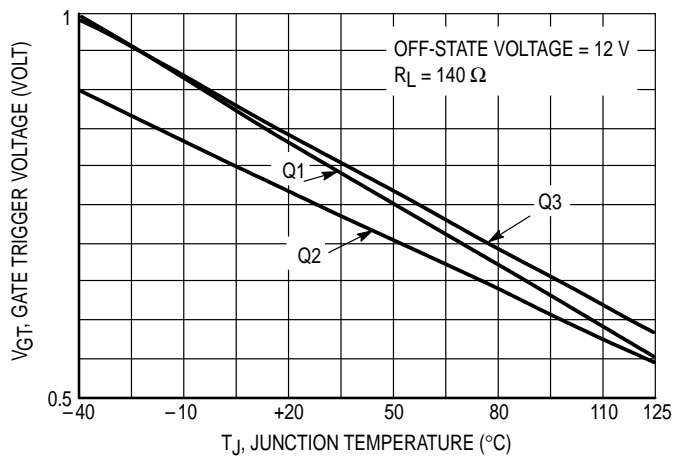

Figure 7. Gate Trigger Voltage Variation

MAC15 SERIES

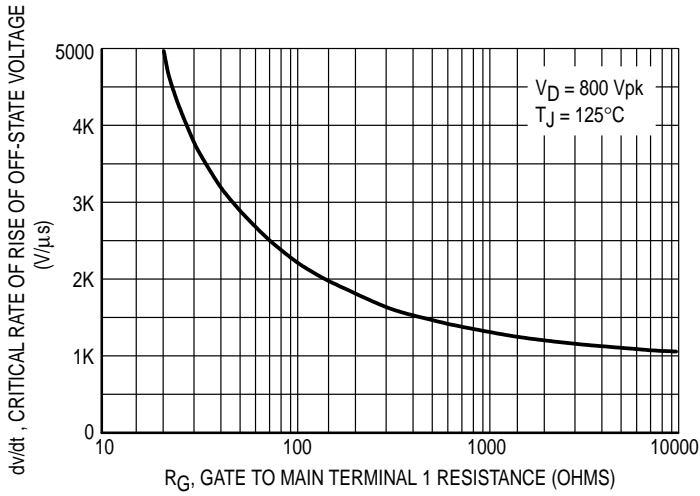

Figure 8. Critical Rate of Rise of Off-State Voltage (Exponential)

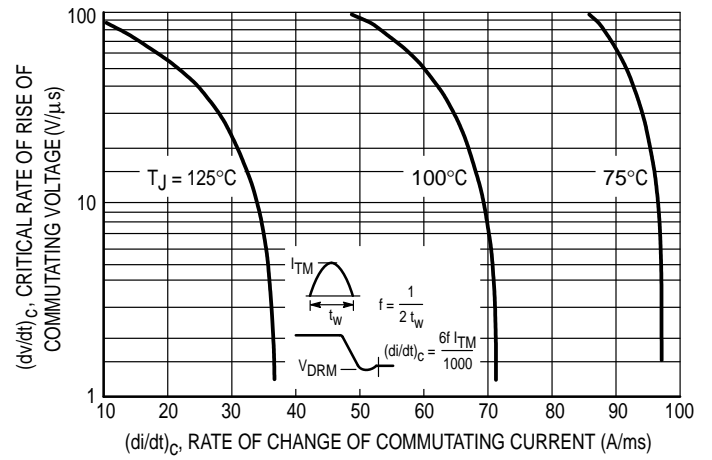
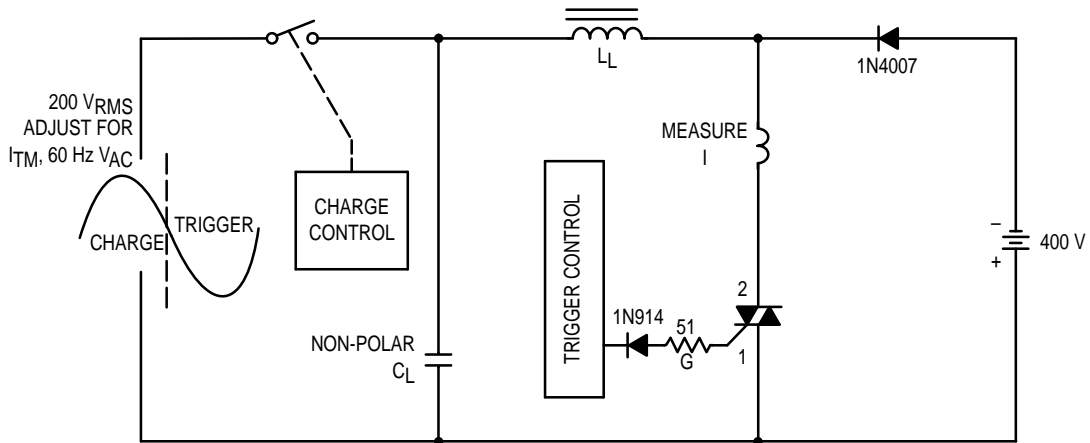

Figure 9. Critical Rate of Rise of Commutating Voltage



Note: Component values are for verification of rated $(dv/dt)_c$. See AN1048 for additional information.

Figure 10. Simplified Test Circuit to Measure the Critical Rate of Rise of Commutating Voltage